

RANDELL®

Custom Design Accessories - Overshelves

Standard Deck-Mounted Overshelf

Constructed of die-formed 16 gauge stainless steel (14 gauge is optional). Supported with stainless tubular uprights.

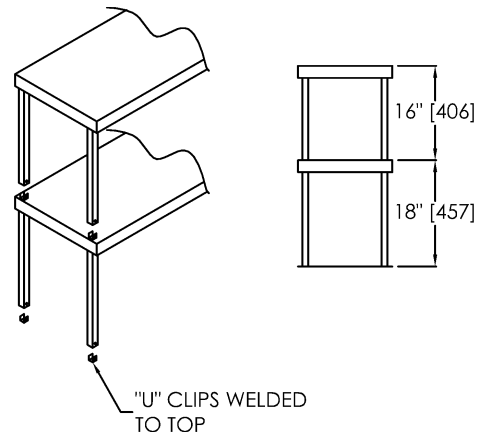

Cantilevered Mounted Overshelf

Constructed of die-formed 16 gauge stainless steel (14 gauge is optional). Supported with 1 5/8" stainless tubular uprights.

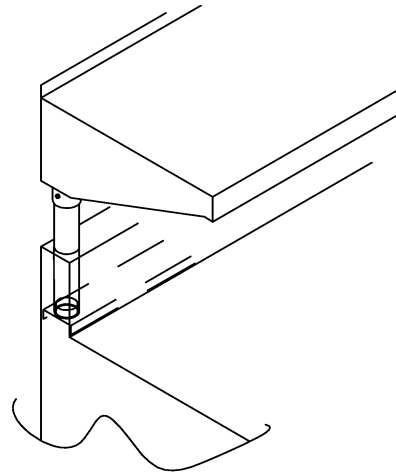

Pass-thru Overshelf

Model # 11069 - Constructed of 16 gauge stainless steel with solid core shelf. Provided with two piece telescoping frame. 18" to 24" widths available on shelf. Frame adjusts for 4 1/2" to 10" wall thickness.

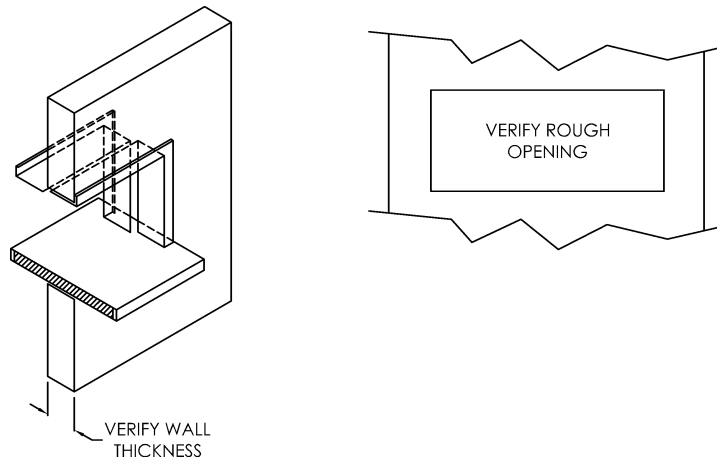

The Randell Patented Drawer Cartridge System!

A fully welded, unitized drawer cartridge assembly with a quick release that allows the refrigerated drawers to be easily removed for cleaning.

- Fully welded 14 gauge unitized Drawer Cartridge assembly.
- 14 gauge drawer tracks on 1 5/8" heavy duty stainless steel bearings.
- Heavy duty full extension tracks to accommodate 12" x 20" x 4" deep pans, two per drawer. Pans by others.
- Quick release allows drawers and liners to be removed without tools.
- Self-closing drawers with stainless steel drawer fronts & easy to grasp drawer handles.

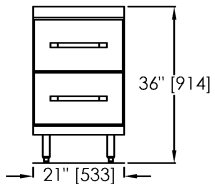
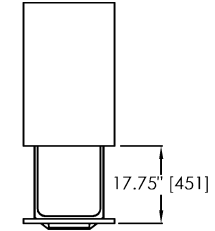

Model C11043-21
Fits standard 21" refrigerated sections. Available in 29" or 33" deep bases. 33" deep model supplied with (1) 12" x 20" x 6" dp. plastic pan per drawer.

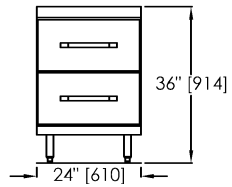
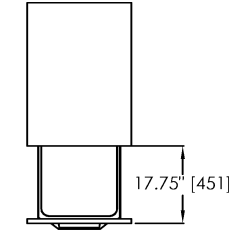

Model C11043-24
Fits standard 24" refrigerated sections. Available in 29" or 33" deep bases. 33" deep model supplied with (1) 12" x 20" x 6" dp. plastic pan per drawer.

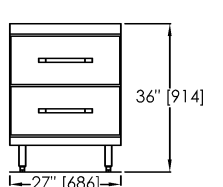
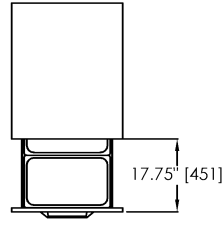

Model C11043-27
Increases standard 24" refrigerated section 3" to 27". - 29" or 33" deep bases. Supplied with (2) 12" x 20" x 6" dp. plastic pans per drawer.

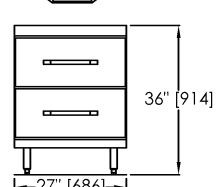
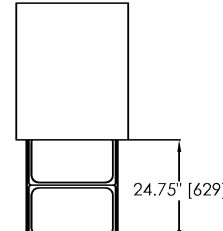

Model C11043-27E
Increases standard 24" refrigerated section 3" to 27" - **33" deep bases only**. Supplied with (2) 12" x 20" x 6" dp. plastic pans per drawer.

Note: 29" deep models supplied with grey ABS tub.

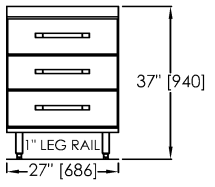
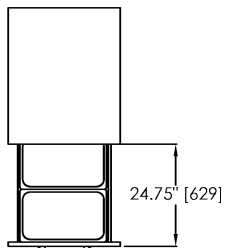

Model C11043-27TE
Increases standard 24" refrigerated section 3" to 27" - **33" deep bases only**. Supplied with (2) 12" x 20" x 4" dp. plastic pans per drawer.

Note: Unit body height is modified to accept (3) tiers of drawers.

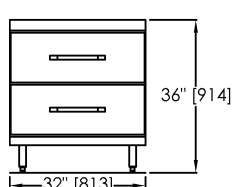
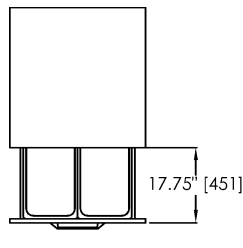

Model C11043-32
Increases standard 24" refrigerated section 8" to 32" - 29" or 33" deep bases. Supplied with (2) 12" x 20" x 6" dp. plastic pans per drawer.

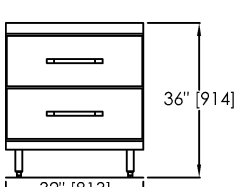
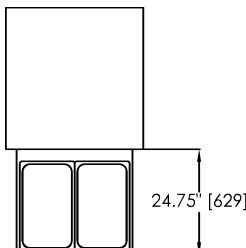

Model C11043-32E
Increases standard 24" refrigerated section 8" to 32" - 29" or 33" deep bases. Supplied with (2) 12" x 20" x 6" dp. plastic pans per drawer.

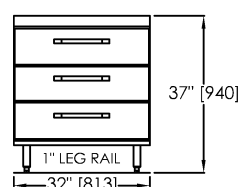
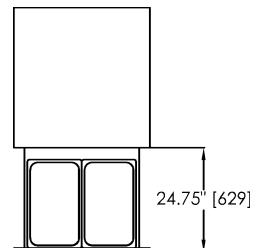

Model C11043-32TE
Increases standard 24" refrigerated section 8" to 32" - 29" or 33" deep bases. Supplied with (2) 12" x 20" x 4" dp. plastic pans per drawer.

